

5 25 143 011 00

unique Spielanlage Maureen, Solo







made in germany

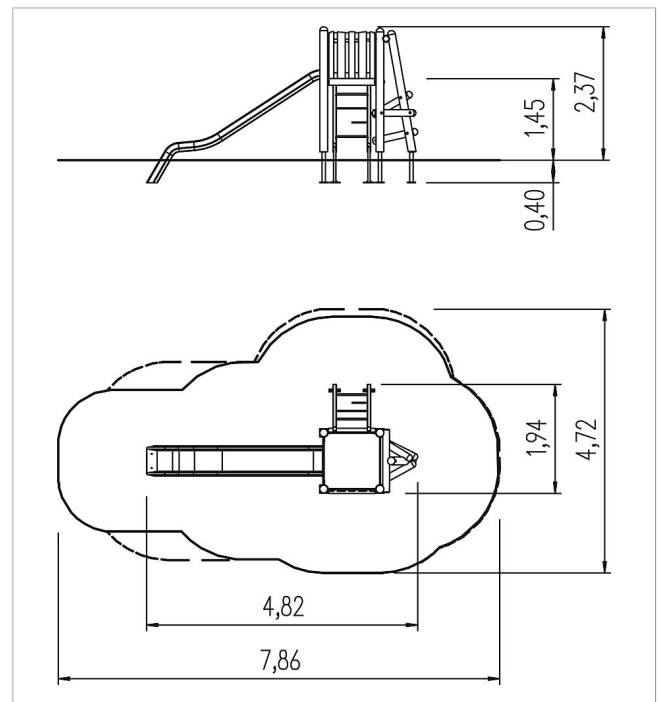

Lieferumfang

- 4x Pfostenkonstruktion: Nadelholz oder Stahl
- 1x Podest: Hochdrucklaminat (HPL)
- 1x Podestkonstruktion: Stahl feuerverzinkt
- 1x Materialeiter: Nadelholz, Edelstahl (V2A), kunststoffummanteltes Stahlseil
- 1x Strebenstammaufstieg: Nadelholz
- 1x Brüstung: Nadelholz
- 1x Durchlaufsicherung: Nadelholz
- 1x Rutscheneinstiegsplatte: Hochdrucklaminat (HPL)
- 1x Griffset: Aluminium, beschichtet
- Beschläge: Edelstahl (V2A)



	Material	NH kdi
	Fundamentlevel	ET 400
	Mindest-Raum	4,76x7,74x3,25 m
	Freie Fallhöhe	145 cm
	Fallschutz netto	25,5 m ²
	Fundamente	7x OF oder 7x FFK
	Größtes Teil	Ø 14x222 cm