

5 66 311 5

## unique Sandwrack Bounty Heck







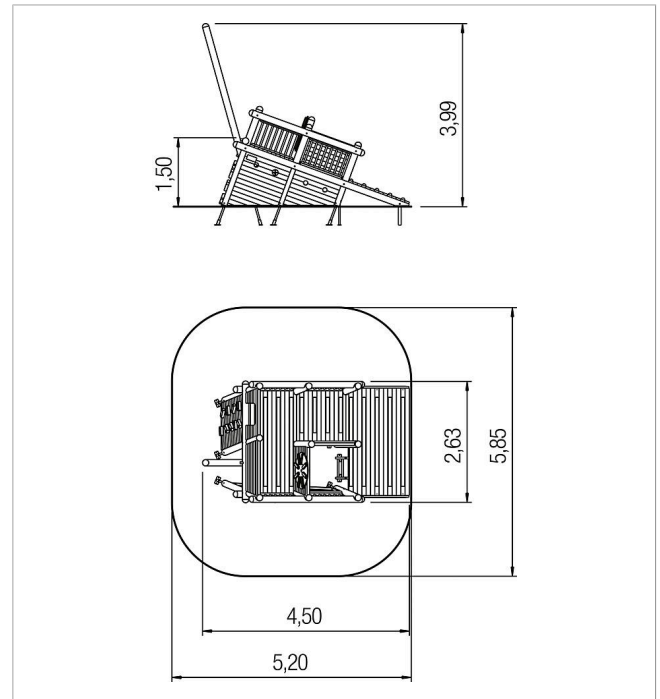

made in germany



### Lieferumfang

1x Schiffsglocke: Messing  
 1x Gravurschild: Messing  
 1x Leiteraufstieg: Esche, Nadelholz  
 1x Steuerrad: Hochdrucklaminat (HPL)  
 Pfostenschuhe: Stahl feuerverzinkt  
 Holzkonstruktion: Nadelholz



	Material	NH kdi
	Fundamentlevel	ET 400
	Mindest-Raum	5,20x5,85x3,99 m
	Freie Fallhöhe	151 cm
	Fallschutz netto	28,5 m <sup>2</sup>
	Fundamente	1x OF oder 14x FFK
	Montage	2 Personen/6 Std.
	Größtes Teil	140x234x11 cm
	Schwerstes Teil	75 kg