

Wassermatschanlage Theda



Altersan-
gabe



Elemente
erfahren



Sozial-
kompetenz



Zusam-
menleben



Inklusion



Sinne



Kreativität

Lieferumfang

1x Podest: Robinie

1x Rinne: Robinie

1x Beck-Becken: Robinie, Edelstahl



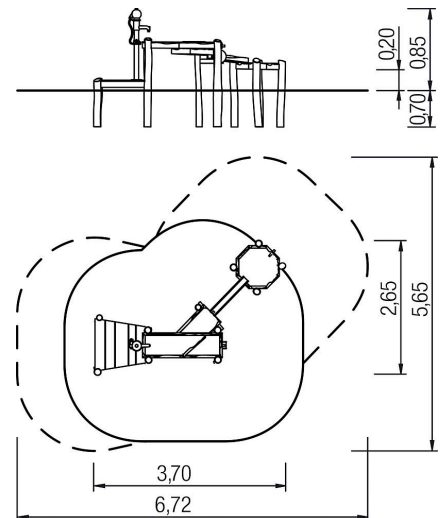



1x Stopfen mit Kette: Robinie, Edelstahl



Wassermatschanlage Theda



Gerätedaten

	Material	Robinie geölt
	Mindest-Raum	6,80x4,00x2,54 m
	Fallschutz netto	-
	freie Fallhöhe	20 cm
	Bodenbeschaffenheit D/NL/B	mind. Stein
	Bodenbeschaffenheit alle außer D/NL/B	mind. Stein

Montageinformation

	Fundamentlevel	ET 700
---	----------------	--------